

EXISTING WELL HOUSE #2

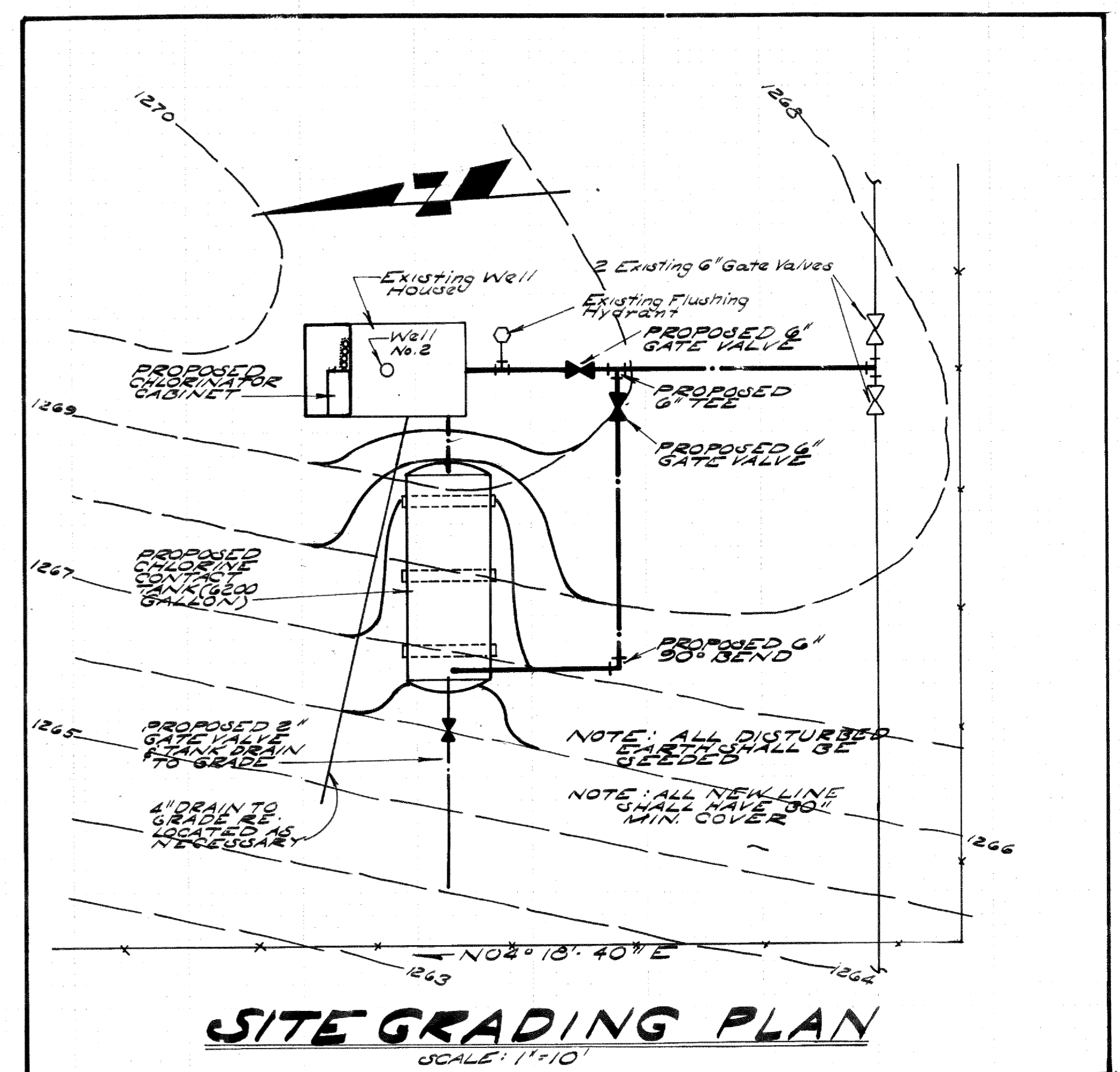

CHLORINE SCHEMATIC

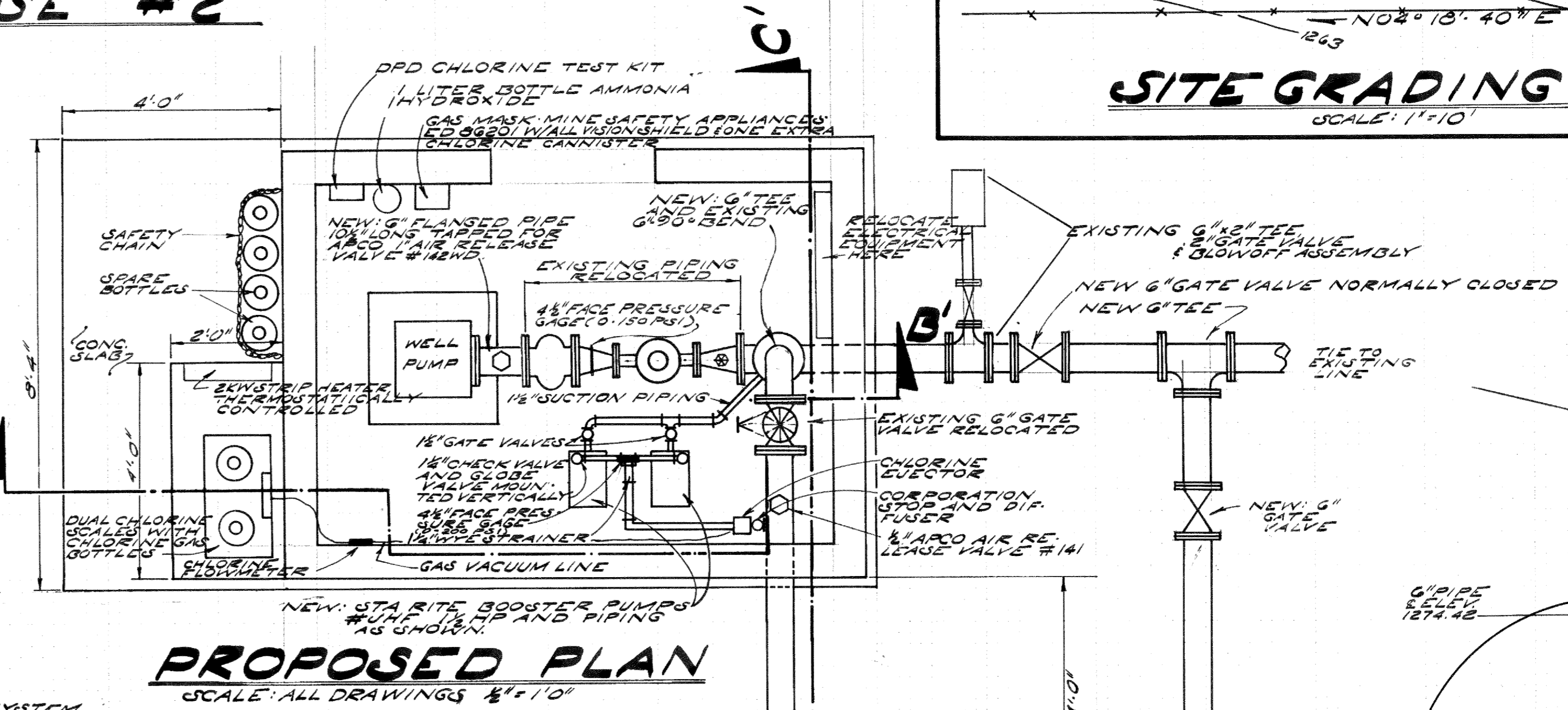
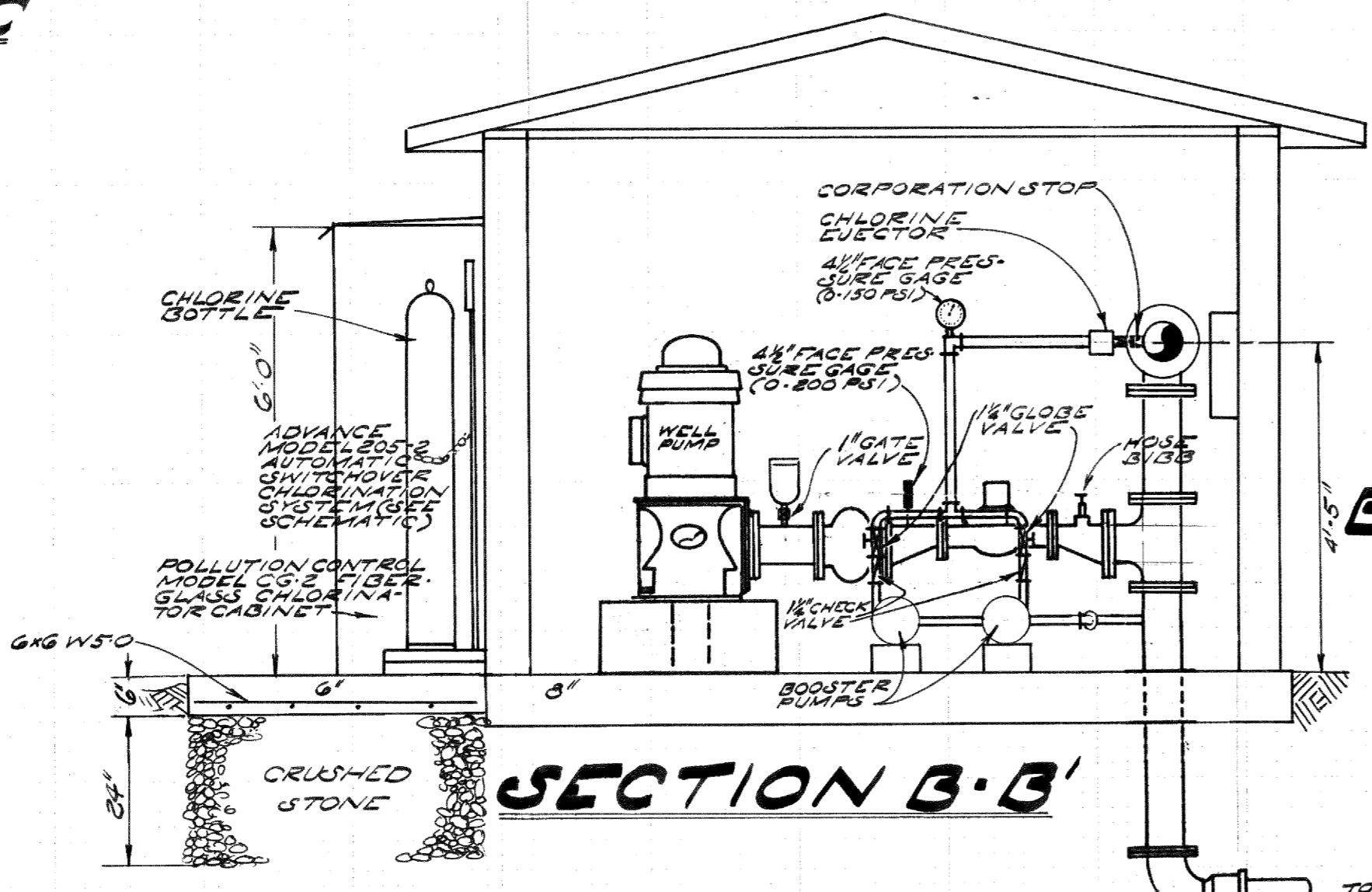
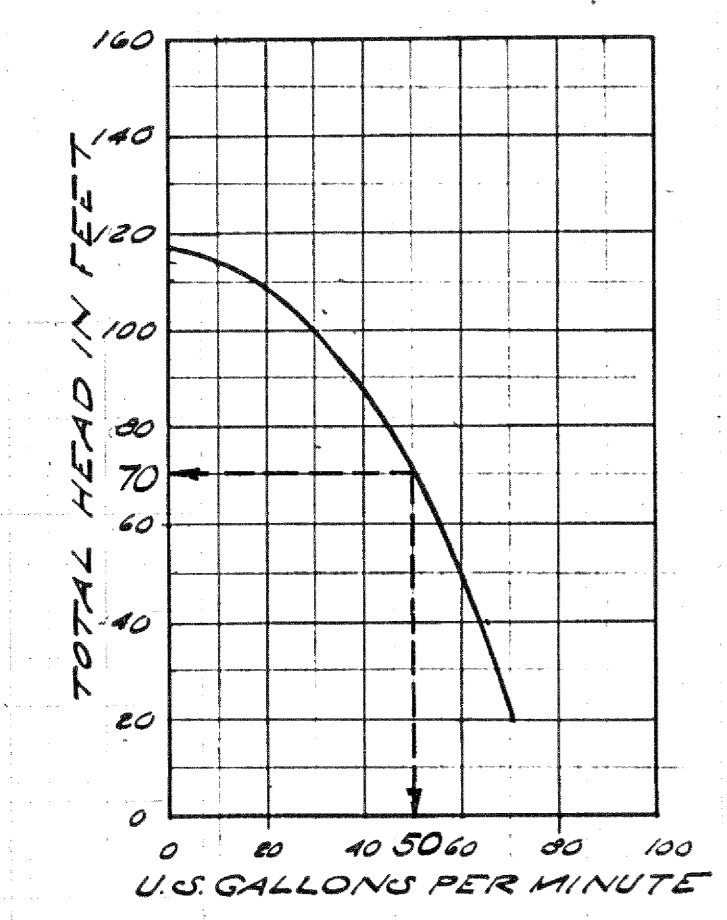

PUMP CURVE

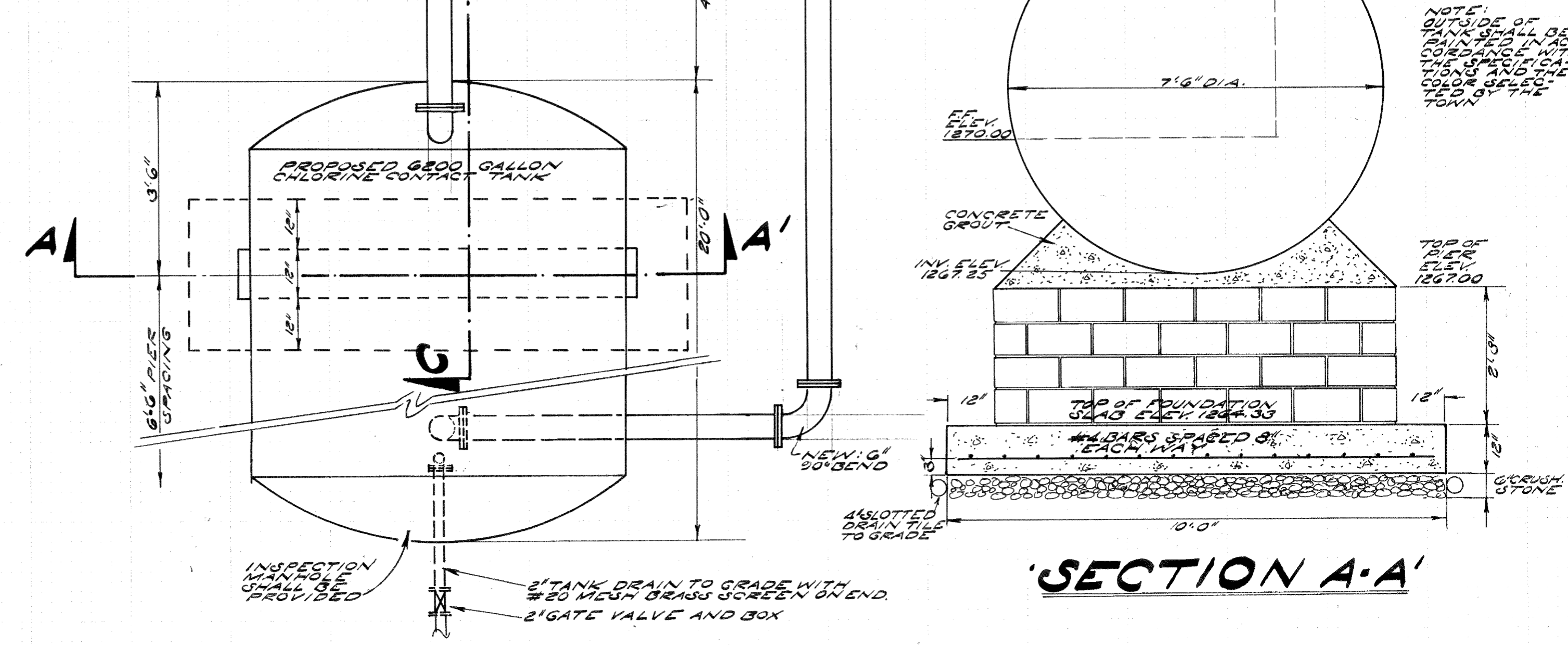
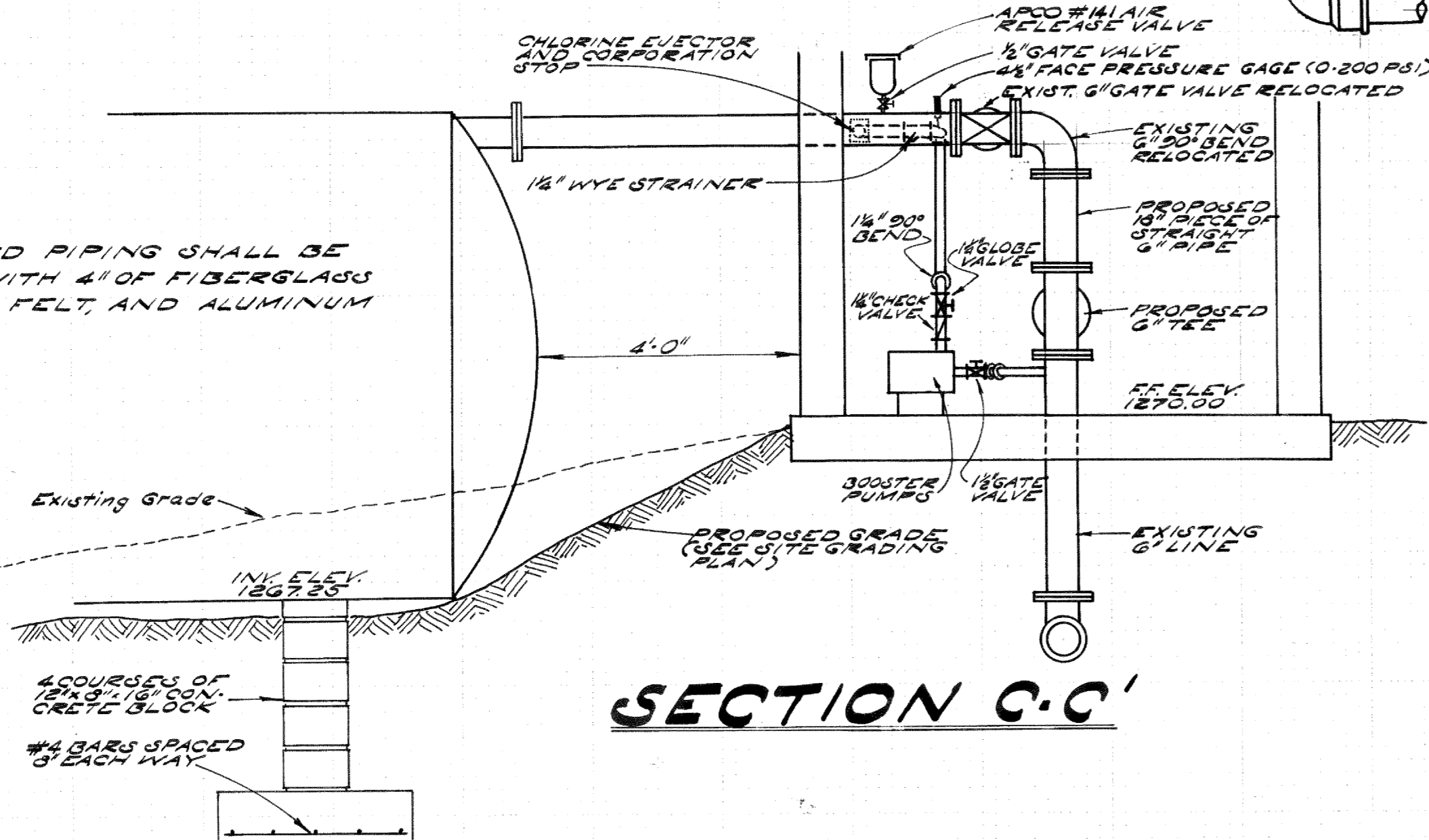

NOTE: ALL EXPOSED PIPING SHALL BE WRAPPED WITH 4" OF FIBERGLASS INSULATION, FELT, AND ALUMINUM TAPE

NOTE: OUTSIDE OF TANK SHALL BE PAINTED IN AN OIL BASED PAINT. THE SPECIFIC COLOR IS TO BE SELECTED BY THE OWNER.

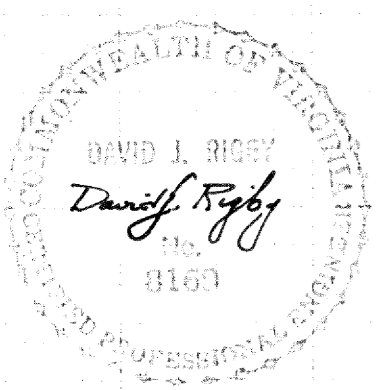

DRAPER - ADEN ASSOCIATES, INC.
ENGINEERS - SURVEYORS - PLANNERS
BLACKSBURG, VIRGINIA

DESIGNED D.J.R.
DRAWN L.H.W.
CHECKED D.J.R.
DATE NOVEMBER 10, 1978

TOWN OF FINCASTLE
CHLORINATION FACILITIES FOR WELL NUMBER 2
VIRGINIA

REVISIONS:

SCALE: AS SHOWN

PLAN No T 75-193

SHEET 1 OF 1